

Article number: 20289B50V50S2BL

Description: E+G Swivel clamp connector - GN 289-B50-V50-S-2-BL

## Measures

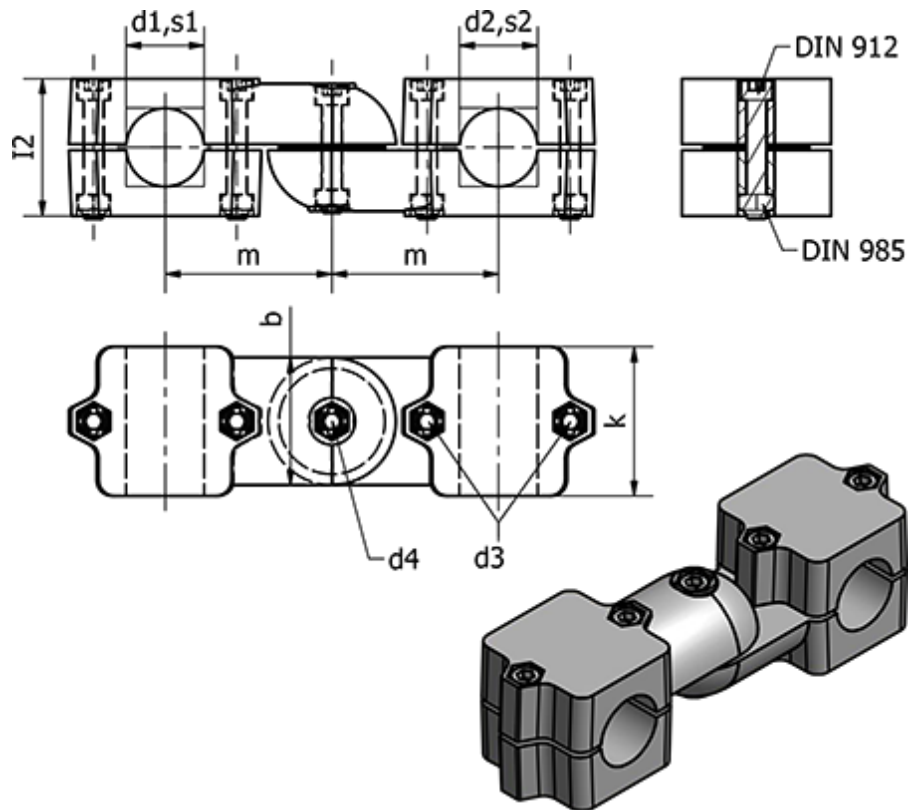

b	= 65	l2	= 70
Clamping kit for d3	= GN 911-M10-55	k	= 76
Clamping kit for d4	= GN 911-M10-63	m	= 85
d1	= B50	s1	= -
d2	= -	s2	= V50
d3	= M10	Weight (g)	= 1593
d4	= M10		
l1	= 268		